

CRUISE CONTROL (MOTOR TYPE)

FROM POWER SOURCE SYSTEM (SEE PAGE 52)

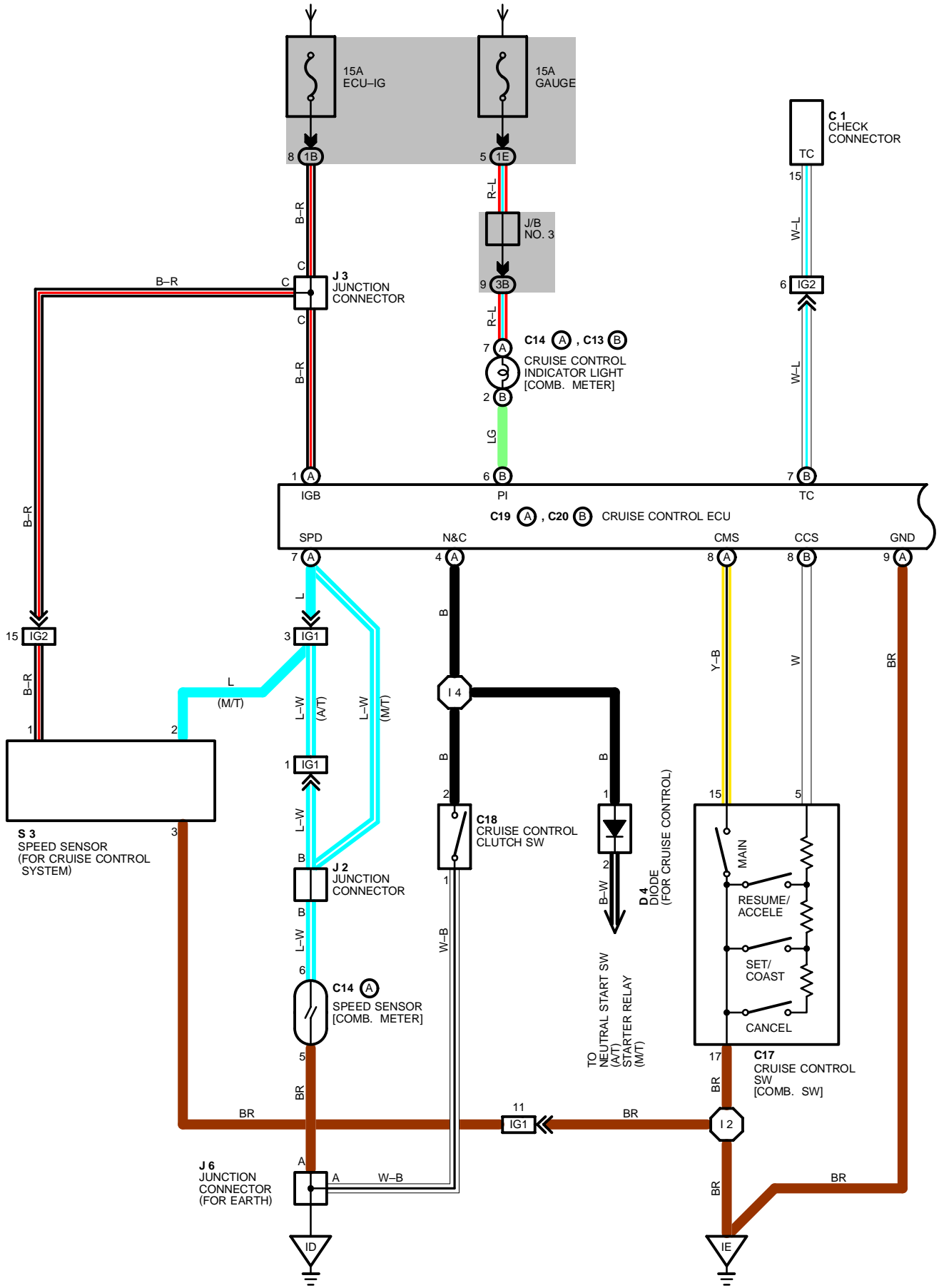

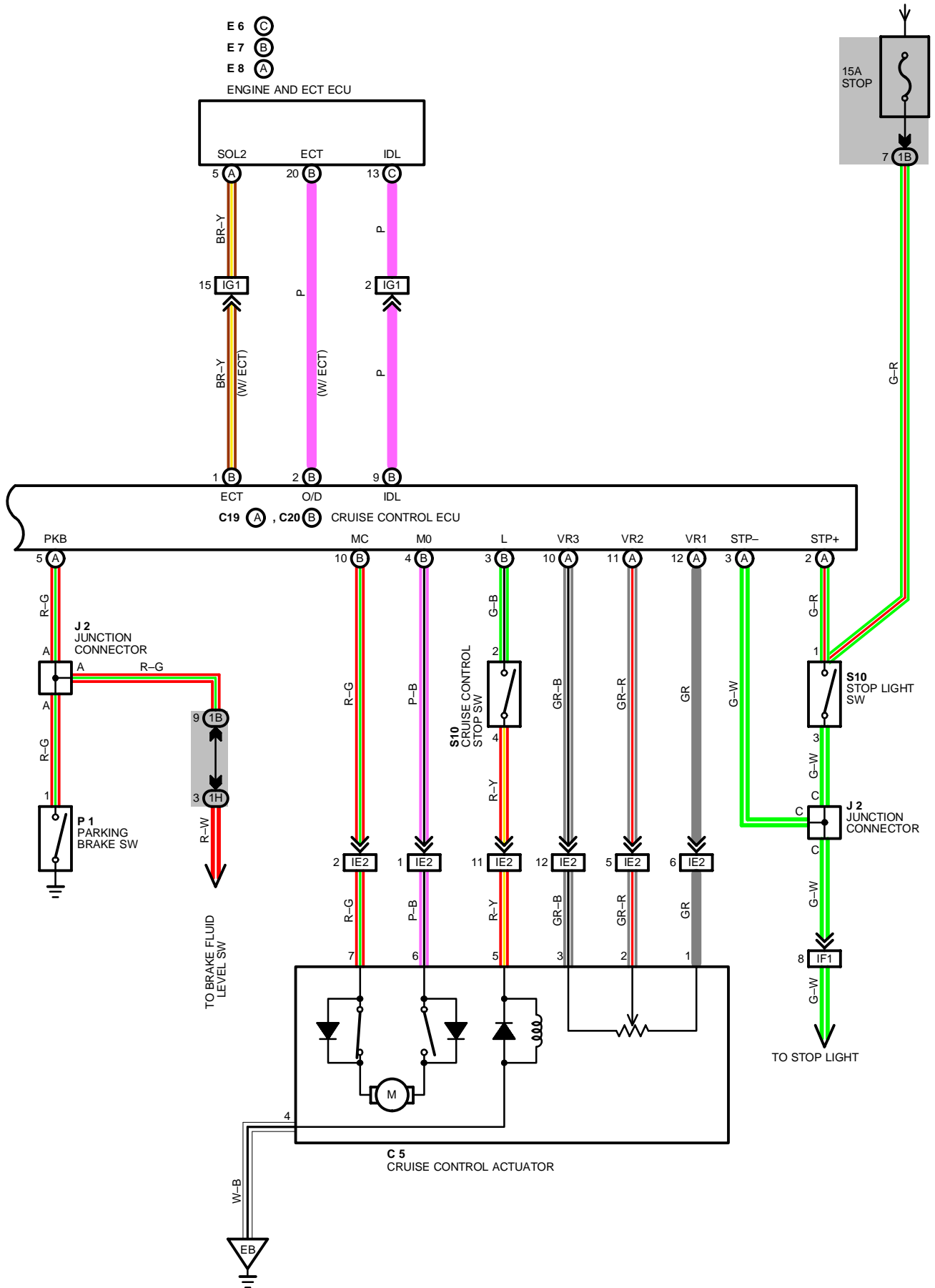

CRUISE CONTROL (MOTOR TYPE)

SYSTEM OUTLINE

CURRENT IS APPLIED AT ALL TIMES THROUGH STOP FUSE TO **TERMINAL (A) 2** OF THE CONTROL ECU AND **TERMINAL 1** OF STOP LIGHT SWITCH, AND ALSO THROUGH THE DOME FUSE TO TERMINAL (A) 6 OF CRUISE CONTROL ECU.

WITH THE IGNITION SWITCH TURNED TO ON, THE CURRENT FLOWS THROUGH GAUGE FUSE TO **TERMINAL (A) 7** OF CRUISE CONTROL INDICATOR LIGHT. THE CURRENT THROUGH ECU-IG FUSE FLOWS TO **TERMINAL (A) 1** OF CRUISE CONTROL ECU AND **TERMINAL 1** OF CRUISE CONTROL SPEED SENSOR.

WHEN THE IGNITION SWITCH IS ON AND THE CRUISE CONTROL MAIN SWITCH IS TURNED ON, A SIGNAL IS INPUT FROM **TERMINAL 15** OF CRUISE CONTROL MAIN SWITCH TO **TERMINAL (A) 8** OF CRUISE CONTROL ECU. AS A RESULT, THE CRUISE CONTROL ECU FUNCTIONS AND THE CURRENT TO **TERMINAL (A) 1** OF CRUISE CONTROL ECU TO **TERMINAL (A) 9** OF CRUISE CONTROL ECU → **GROUND**, AND THE CRUISE CONTROL SYSTEM IS IN A CONDITION READY FOR OPERATION.

AT THE SAME TIME, THE CURRENT THROUGH THE GAUGE FUSE FLOWS FROM **TERMINAL (A) 7** OF CRUISE CONTROL INDICATOR LIGHT → **TERMINAL (B) 2** → **TERMINAL (B) 6** OF CRUISE CONTROL ECU → **TERMINAL (A) 9** → TO **GROUND**, CAUSING THE CRUISE CONTROL INDICATOR LIGHT TO LIGHT UP, INDICATING THAT THE CRUISE CONTROL IS READY FOR OPERATION.

1. SET OPERATION

WHEN THE CRUISE CONTROL MAIN SWITCH IS TURNED ON AND THE SET SWITCH IS PUSHED WITH THE VEHICLE SPEED WITHIN THE SET LIMIT (APPROX. 36KM/H, 22MPH TO 200KM/H, 124MPH), A SIGNAL IS INPUT TO **TERMINAL (B) 8** OF THE CRUISE CONTROL ECU AND THE VEHICLE SPEED AT THE TIME THE SET SWITCH IS RELEASED IS MEMORIZED IN THE ECU AS THE SET SPEED.

2. SET SPEED CONTROL

DURING CRUISE CONTROL DRIVING, THE ECU COMPARES THE SET SPEED MEMORIZED IN THE ECU WITH THE ACTUAL VEHICLE SPEED INPUT INTO **TERMINAL (A) 7** OF THE CRUISE CONTROL ECU FROM THE SPEED SENSOR, AND CONTROLS THE CRUISE CONTROL ACTUATOR TO MAINTAIN THE SET SPEED.

WHEN THE ACTUAL SPEED IS LOWER THAN THE SET SPEED, THE ECU CAUSES THE CURRENT TO THE CRUISE CONTROL ACTUATOR TO FLOW FROM **TERMINAL (B) 4** → **TERMINAL 6** OF CRUISE CONTROL ACTUATOR → **TERMINAL 7** → **TERMINAL (B) 10** OF CRUISE CONTROL ECU. AS A RESULT, THE MOTOR IN THE CRUISE CONTROL ACTUATOR IS ROTATED TO OPEN THE THROTTLE VALVE AND THE THROTTLE CABLE IS PULLED TO INCREASE THE VEHICLE SPEED. WHEN THE ACTUAL DRIVING SPEED IS HIGHER THAN THE SET SPEED, THE CURRENT TO CRUISE CONTROL ACTUATOR FLOWS FROM **TERMINAL (B) 10** OF ECU → **TERMINAL 7** OF CRUISE CONTROL ACTUATOR → **TERMINAL 6** → **TERMINAL (B) 4** OF CRUISE CONTROL ECU.

THIS CAUSES THE MOTOR IN THE CRUISE CONTROL ACTUATOR TO ROTATE TO CLOSE THE THROTTLE VALVE AND RETURN THE THROTTLE CABLE TO DECREASE THE VEHICLE SPEED.

3. COAST CONTROL

DURING THE CRUISE CONTROL DRIVING, WHILE THE COAST SWITCH IS ON, THE CRUISE CONTROL ACTUATOR RETURNS THE THROTTLE CABLE TO CLOSE THE THROTTLE VALVE AND DECREASE THE DRIVING SPEED. THE VEHICLE SPEED WHEN THE COAST SWITCH IS TURNED OFF AND IS MEMORIZED AND THE VEHICLE CONTINUES AT THE NEW SET SPEED.

4. ACCEL CONTROL

DURING CRUISE CONTROL DRIVING, WHILE THE ACCEL SWITCH IS TURNED ON, THE CRUISE CONTROL ACTUATOR PULLS THE THROTTLE CABLE TO OPEN THE THROTTLE VALVE AND INCREASE THE DRIVING SPEED. THE VEHICLE SPEED WHEN THE ACCEL SWITCH IS TURNED OFF IS MEMORIZED AND THE VEHICLE CONTINUES AT THE NEW SET SPEED.

5. RESUME CONTROL

UNLESS THE VEHICLE SPEED FALLS BELOW THE MINIMUM SPEED LIMIT (APPROX. 40KM/H, 25MPH) AFTER CANCELING THE SET SPEED BY THE CANCEL SWITCH, PUSHING THE RESUME SWITCH WILL CAUSE THE VEHICLE TO RESUME THE SPEED SET BEFORE CANCELLATION.

6. MANUAL CANCEL MECHANISM

IF ANY OF THE FOLLOWING OPERATIONS OCCURS DURING CRUISE CONTROL OPERATION, THE SAFETY MAGNET CLUTCH OF THE ACTUATOR MOTOR TURNS OFF AND THE MOTOR ROTATES TO CLOSE THE THROTTLE VALVE AND THE CRUISE CONTROL IS RELEASED.

- * PLACING THE SHIFT LEVER IN "N" RANGE (NEUTRAL START SWITCH ON). "SIGNAL INPUT TO **TERMINAL (A) 4** OF ECU"
- * DEPRESSING THE BRAKE PEDAL (STOP LIGHT SWITCH ON). "SIGNAL INPUT TO **TERMINAL (A) 2** OF ECU"
- * DEPRESSING THE PARKING BRAKE PEDAL (PARKING BRAKE SWITCH ON). "SIGNAL INPUT TO **TERMINAL (A) 5** OF ECU"
- * PUSH THE CANCEL SWITCH (CANCEL SWITCH ON). "SIGNAL INPUT TO **TERMINAL (B) 8**"

7. AUTO CANCEL FUNCTION

A) IF ANY OF THE FOLLOWING OPERATE CONDITIONS OCCURS DURING CRUISE CONTROL OPERATION. THE SET SPEED IS ERASED, CURRENT FLOW TO SAFETY MAGNETIC CLUTCH IS STOPPED AND THE CRUISE CONTROL IS RELEASED. (MAIN SWITCH TURNS OFF).

WHEN THIS OCCURS, THE IGNITION SWITCH MUST BE TURNED OFF ONCE BEFORE THE MAIN SWITCH WILL TURN ON.

- * OVER CURRENT TO TRANSISTOR DRIVING MOTOR AND/OR SAFETY MAGNETIC CLUTCH.
- * CURRENT TO CONTROL THE THROTTLE VALVE IN MOTOR BECOMES ALWAYS "ON".
- * OPEN CIRCUIT IN SAFETY MAGNETIC CLUTCH.
- * MOMENTARY INTERRUPTION OF VEHICLE SPEED SIGNAL.
- * THE RESUME SWITCH IS ALREADY ON WHEN THE MAIN SWITCH IS TURNED ON.
- * SHORT CIRCUIT IN CRUISE CONTROL SWITCH.
- * MOTOR DOES NOT OPERATE DESPITE THE MOTOR DRIVE SIGNAL BEING OUTPUT.

B) IF ANY OF THE FOLLOWING CONDITIONS OCCUR DURING CRUISE CONTROL OPERATION, THE SET SPEED IS ERASED AND THE CRUISE CONTROL IS RELEASED. (THE POWER OF SAFETY MAGNETIC CLUTCH IS CUT OFF UNTIL THE SET SWITCH IS "ON" AGAIN.)

- * WHEN THE VEHICLE SPEED FALLS BELOW THE MINIMUM SPEED LIMIT, APPROX. 36 KM/H (22 MPH).
- * WHEN THE VEHICLE SPEED FALLS MORE THAN 16 KM/H (10 MPH) BELOW THE SET SPEED, E.G. ON AN UPWARD SLOPE.
- * WHEN POWER TO THE CRUISE CONTROL SYSTEM IS MOMENTARILY CUT OFF.

C) IF ANY OF THE FOLLOWING CONDITIONS OCCURS DURING CRUISE CONTROL OPERATION, THE CRUISE CONTROL IS RELEASED. BUT IN THIS CASE, THE SET SPEED IS NOT ERASED. IF THE VEHICLE SPEED IS MORE THAN THE MINIMUM SPEED LIMIT (APPROX. 36 KM/H 22 MPH), CRUISE CONTROL OPERATION IS POSSIBLE USING "SET" OR "RESUME" ON THE CONTROL SWITCH.

- * OPEN CIRCUIT FOR **TERMINAL (A) 3** OF CRUISE CONTROL ECU AND **TERMINAL 3** OF STOP LIGHT SWITCH.

8. AUTOMATIC TRANSMISSION CONTROL FUNCTION

* IN OVERDRIVE. IF THE VEHICLE SPEED BECOMES LOWER THAN THE OVERDRIVE CUT SPEED (SET SPEED MINIMUM 4 KM/H, 2.5 MPH) DURING CRUISE CONTROL OPERATION, SUCH AS DRIVING UP A HILL, THE OVERDRIVE IS RELEASED AND THE POWER INCREASED TO PREVENT A REDUCTION IN VEHICLE SPEED.

* AFTER RELEASING THE OVERDRIVE, THE VEHICLE SPEED BECOMES HIGHER THAN THE OVERDRIVE RETURN SPEED (SET SPEED MINIMUM 2 KM/H 1.2 MPH) AND THE ECU JUDGES BY THE SIGNALS FROM POTENTIO METER OF THE ACTUATOR THAT THE UPWARD SLOPE HAS FINISHED, OVERDRIVE IS RESUMED AFTER APPROXIMATELY 6 SECONDS.

* DURING CRUISE CONTROL DRIVING, THE CRUISE CONTROL OPERATION SIGNAL IS OUTPUT FROM THE CRUISE CONTROL ECU TO THE ENGINE AND TRANSMISSION ECU. UPON RECEIVING THIS SIGNAL, THE ENGINE AND TRANSMISSION ECU CHANGES THE SHIFT PATTERN TO NORMAL.

TO MAINTAIN SMOOTH CRUISE CONTROL OPERATION (ON A DOWNWARD SLOPE ECT.), LOCK-UP RELEASE OF THE TRANSMISSION WHEN THE IDLING POINT OF THE THROTTLE POSITION IS "ON" IS FORBIDDEN.

SERVICE HINTS

C 5 CRUISE CONTROL ACTUATOR

1-3 : APPROX. 2 K Ω

5-4 : APPROX. 38.5 Ω

C17 CRUISE CONTROL SW [COMB. SW]

15-17 : CONTINUITY WITH MAIN SW ON

5-17 : APPROX. 413 Ω WITH CANCEL SW ON

APPROX. 68 Ω WITH RESUME/ACCEL SW ON

APPROX. 198 Ω WITH SET/COAST SW ON

C19(A), C20(B) CRUISE CONTROL ECU

(A) 1-GROUND : APPROX. 12 VOLTS WITH IGNITION SW AT ON POSITION

(A) 2, 6-GROUND : ALWAYS APPROX. 12 VOLTS

(A) 5-GROUND : CONTINUITY WITH PARKING BRAKE LEVER PULLED UP (ONE OF THE CANCEL SW) OR BRAKE LEVEL WARNING SW ON

(A) 7-GROUND : 1 PULSE EACH 40 CM (DRIVER VEHICLE SLOWLY)

(B) 8-GROUND : APPROX. 419 Ω WITH CANCEL SW ON IN CONTROL SW
APPROX. 68 Ω WITH RESUME/ACCEL SW ON IN CONTROL SW
APPROX. 198 Ω WITH SET/COAST SW ON IN CONTROL SW

(A) 9-GROUND : ALWAYS CONTINUITY

○ : PARTS LOCATION

CODE	SEE PAGE	CODE	SEE PAGE	CODE	SEE PAGE
C 1	26 (5S-FE)	C19	A 28	J 2	29
C 5	26 (5S-FE)	C20	B 28	J 3	29
C13	B 28	D 4 28		J 6	29
C14	A 28	E 6	C 29	P 1	29
C17	28	E 7	B 29	S 3	26 (5S-FE)
C18	28	E 8	A 29	S10	29

CRUISE CONTROL (MOTOR TYPE)

: JUNCTION BLOCK AND WIRE HARNESS CONNECTOR

CODE	SEE PAGE	JUNCTION BLOCK AND WIRE HARNESS (CONNECTOR LOCATION)
1B	18	COWL WIRE AND J/B NO.1 (LEFT KICK PANEL)
1E		
1H	18	ENGINE ROOM MAIN WIRE AND J/B NO. 1 (LEFT KICK PANEL)
3B	22	COWL WIRE AND J/B NO.3 (BEHIND COMBINATION METER)

: CONNECTOR JOINING WIRE HARNESS AND WIRE HARNESS

CODE	SEE PAGE	JOINING WIRE HARNESS AND WIRE HARNESS (CONNECTOR LOCATION)
IE2	36	ENGINE ROOM MAIN WIRE AND COWL WIRE (LEFT KICK PANEL)
IF1	36	FLOOR WIRE AND COWL WIRE (LEFT KICK PANEL)
IG1	36	ENGINE WIRE AND COWL WIRE (UNDER THE ENGINE ECU)
IG2		

: GROUND POINTS

CODE	SEE PAGE	GROUND POINTS LOCATION
EB	32 (5S-FE)	FRONT LEFT FENDER
	34 (4A-FE)	
ID	36	LEFT KICK PANEL
IE	36	INSTRUMENT PANEL BRACE LH

: SPLICE POINTS

CODE	SEE PAGE	WIRE HARNESS WITH SPLICE POINTS	CODE	SEE PAGE	WIRE HARNESS WITH SPLICE POINTS
I2	36	COWL WIRE	I4	36	COWL WIRE

C 1 DARK GRAY

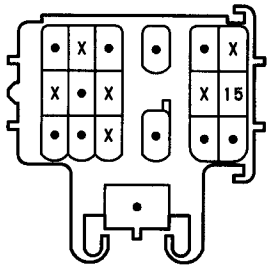

C 5 GRAY

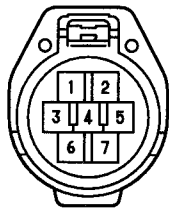

C13 (B) BROWN

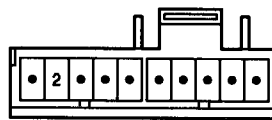

C14 (A)

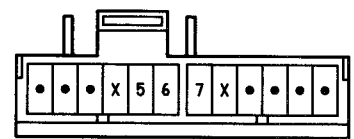

C17 BLACK

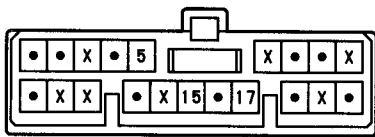

C18



C19 (A)

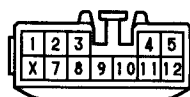

C20 (B)

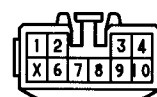

D 4



E 6 (C) DARK GRAY

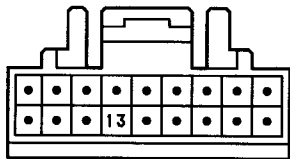

E 7 (B) DARK GRAY

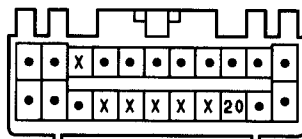

E 8 (A) DARK GRAY

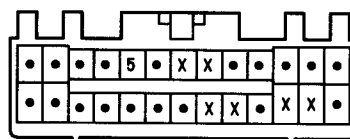

J 2

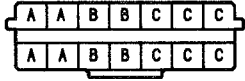

(HINT:SEE PAGE 7)

J 3

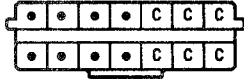

(HINT:SEE PAGE 7)

J 6

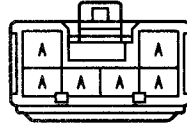

(HINT:SEE PAGE 7)

P 1 BLACK



S 3 GRAY



S10

