

ELECTROSTATIC DISCHARGE WARNING - BASIC INFORMATION

1993 Toyota Celica

GENERAL INFORMATION

Electrostatic Discharge (ESD) Warning - Basic Information

All Makes and Models

* PLEASE READ THIS FIRST *

NOTE: This article is intended for general information purposes only.

INTRODUCTION

All Electrostatic Discharge (ESD) sensitive components contain solid state circuits (transistors, diodes, semiconductors) that may become damaged when contacted with an electrostatic charge. The following information applies to all ESD sensitive devices. The ESD symbol shown in Fig. 1 may be used on schematics to indicate which components are ESD sensitive. See Fig. 1. Although different manufactures may display different symbols to represent ESD sensitive devices, the handling and measuring precautions and procedures are the same.

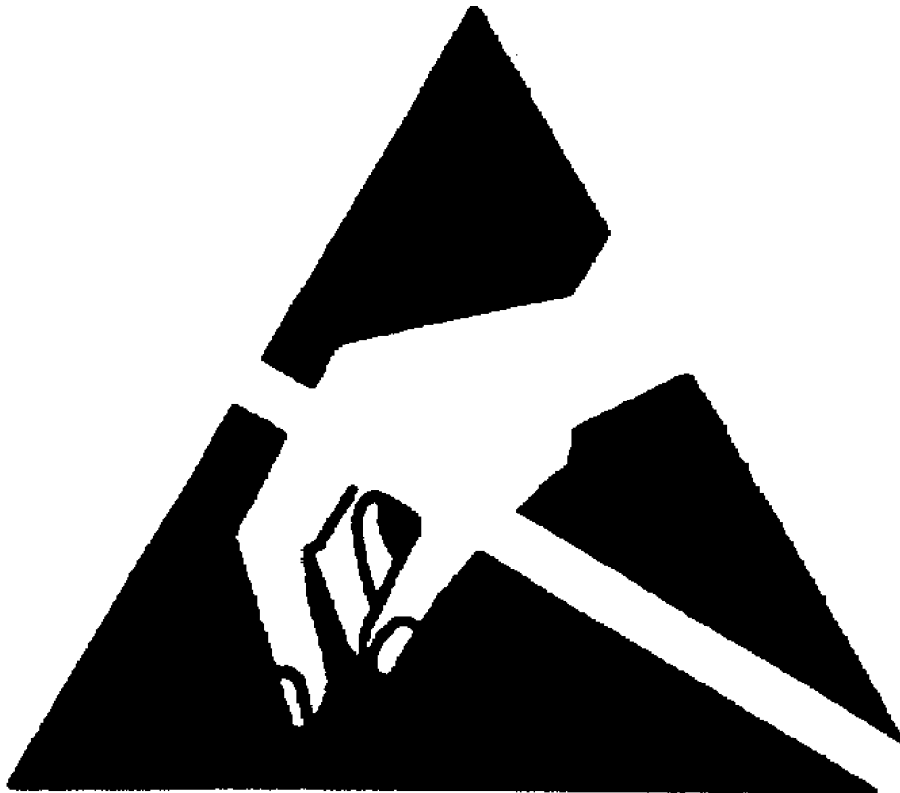

Fig. 1: Sample ESD Symbol

HANDLING STATIC-SENSITIVE CIRCUITS/DEVICES

When handling an electronic part that is ESD sensitive, the technician should follow these guidelines to reduce any possible electrostatic charge build-up on the technician's body and the electronic part.

1) Always touch a known good ground source before handling the part. This should be repeated while handling the part and more frequently after sitting down from a standing position, sliding across the seat or walking a distance.

2) Avoid touching electrical terminals of the part, unless instructed by a diagnostic procedure.

3) DO NOT open the package of a new part until it is time to install the part.

4) Before removing the part from its package, ground the package to a known good ground source.

CHECKING STATIC-SENSITIVE CIRCUITS/DEVICES

1) Solid State circuits in electronic devices are shown greatly simplified in schematics. See Fig. 2. Due to the simplification of the electronic devices on the schematic, resistance measurements could be misleading or could lead to an electrostatic discharge. Always follow the recommended diagnostic procedure.

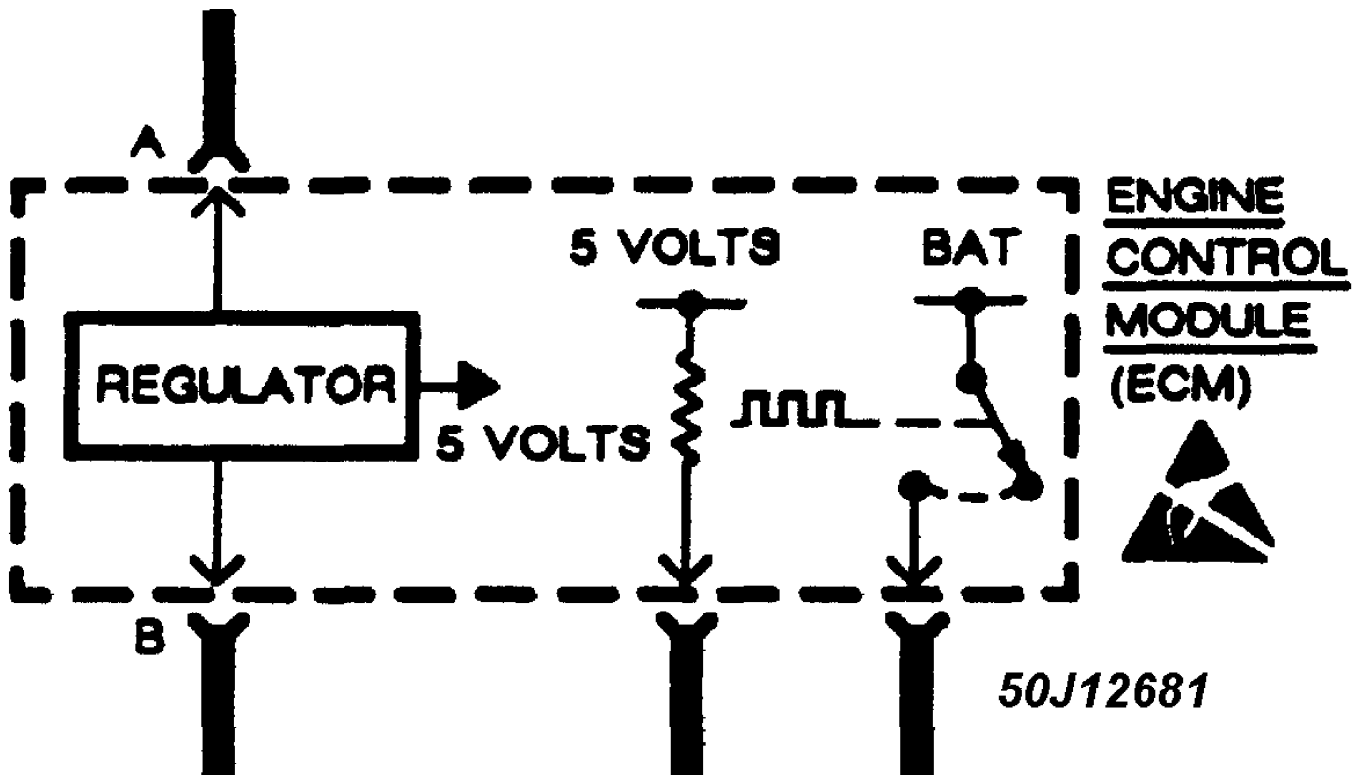

Fig. 2: Sample Schematic Showing Typical ESD Sensitive Device

2) Only measure resistance at the terminals of the devices when instructed by the recommended diagnostic procedure.

3) When using a voltmeter, be sure to connect the ground lead first.