

# VACUUM DIAGRAMS

1988 Toyota Celica

1988 EXHAUST EMISSION SYSTEMS  
Toyota Vacuum Diagrams

## VACUUM DIAGRAMS

CAMRY & CELICA

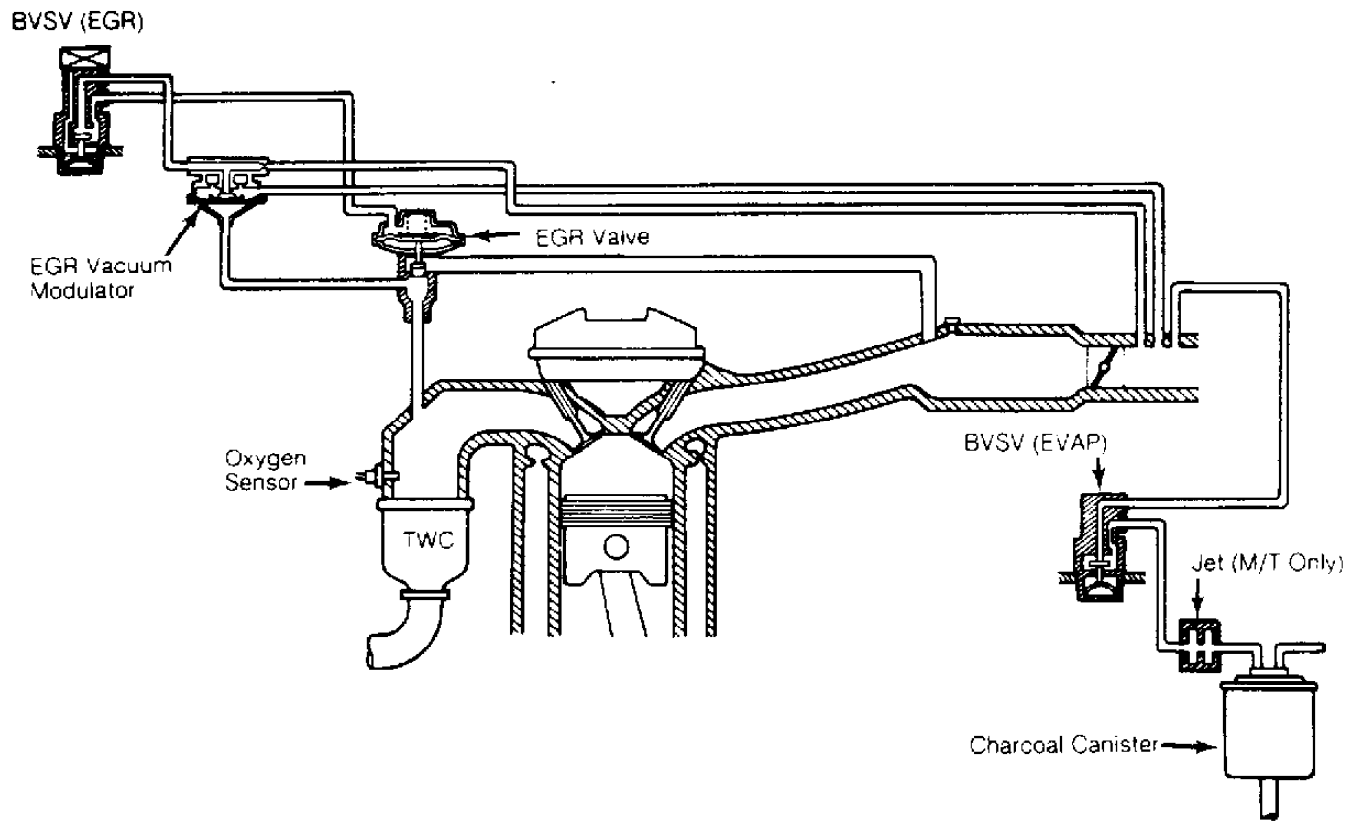

Fig. 1: Camry & Celica 2.0L Non-Turbo  
Courtesy of Toyota Motor Sales, U.S.A., Inc.

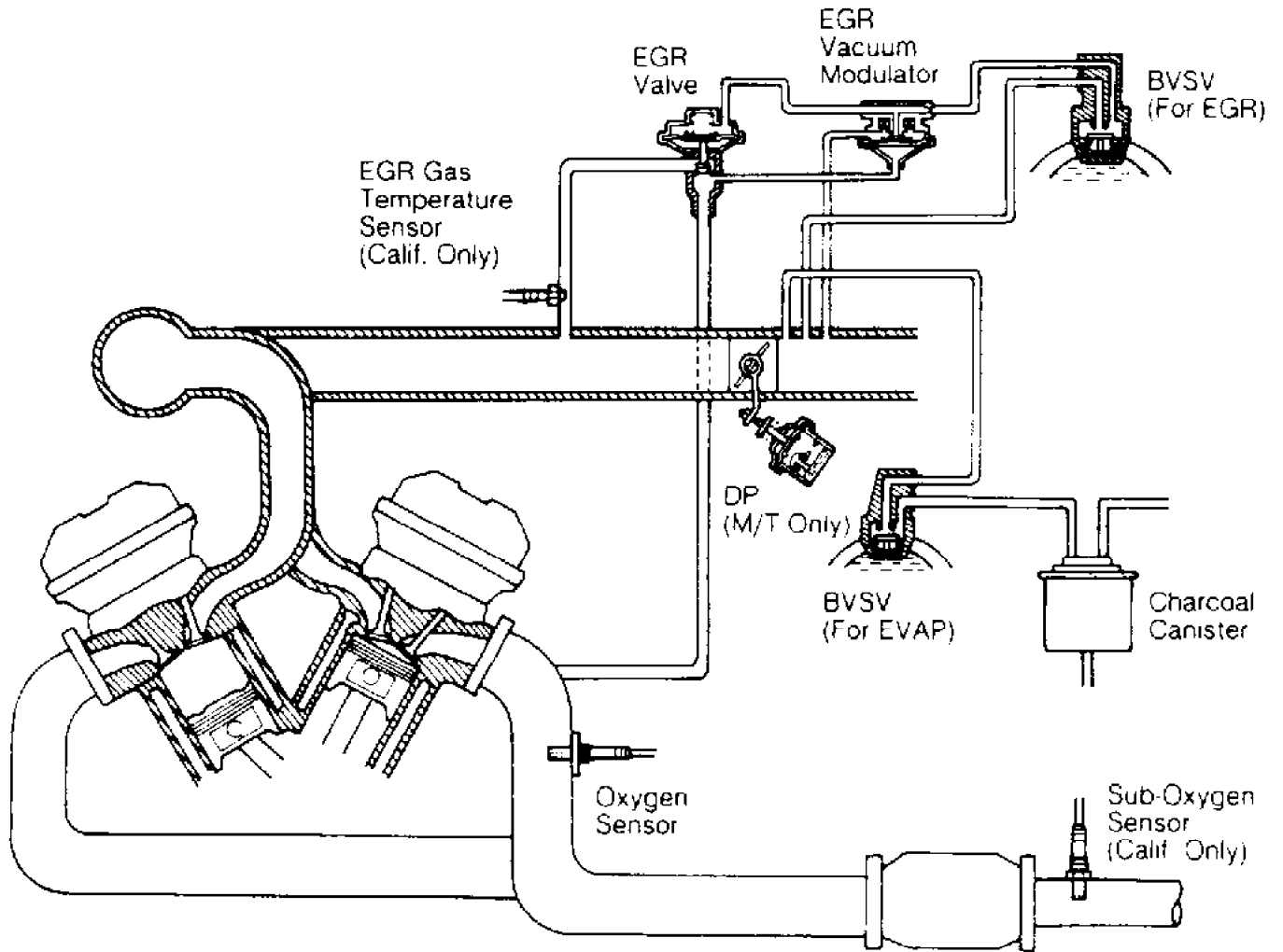

Fig. 2: 1988 1/2 Camry 2.5L V6 (VZV Series)  
 Courtesy of Toyota Motor Sales, U.S.A., Inc.

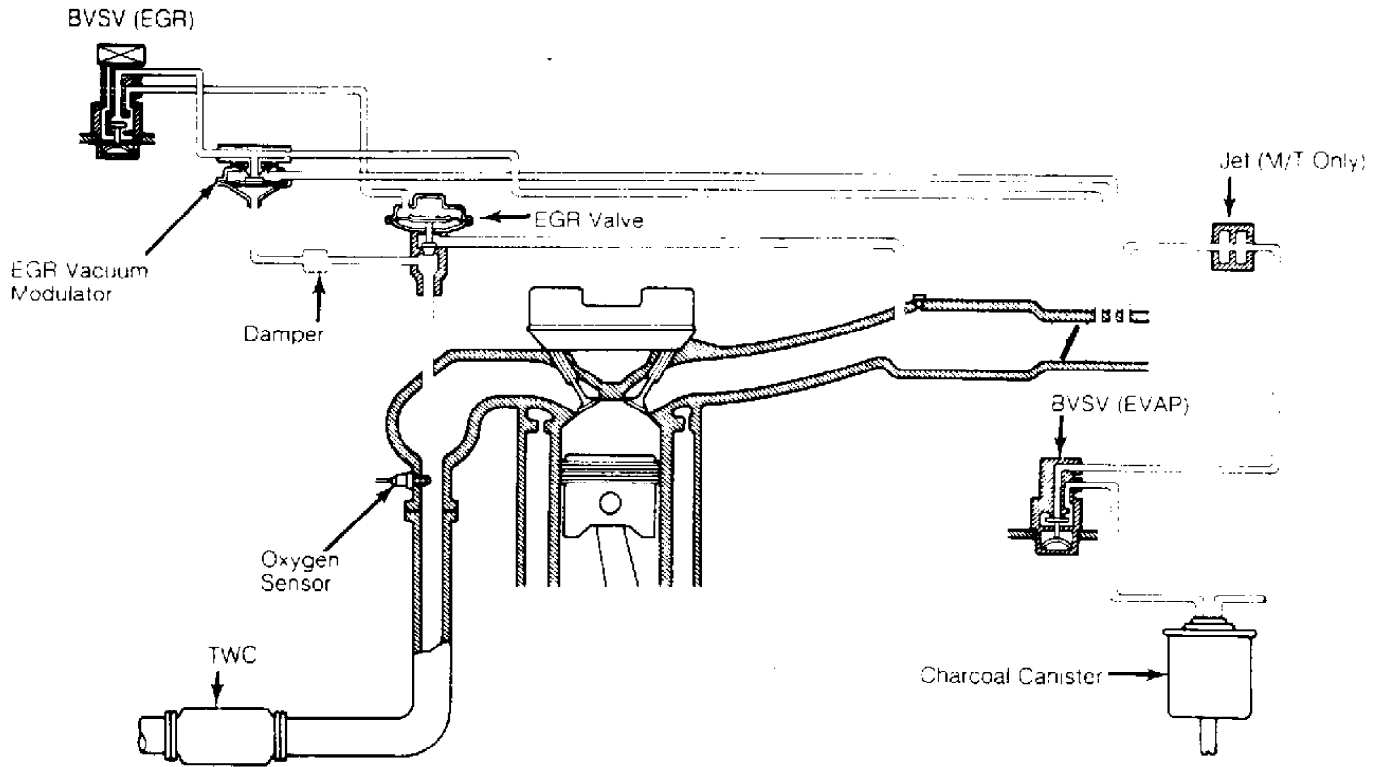

Fig. 3: Celica 2.0L (Turbo)  
 Courtesy of Toyota Motor Sales, U.S.A., Inc.

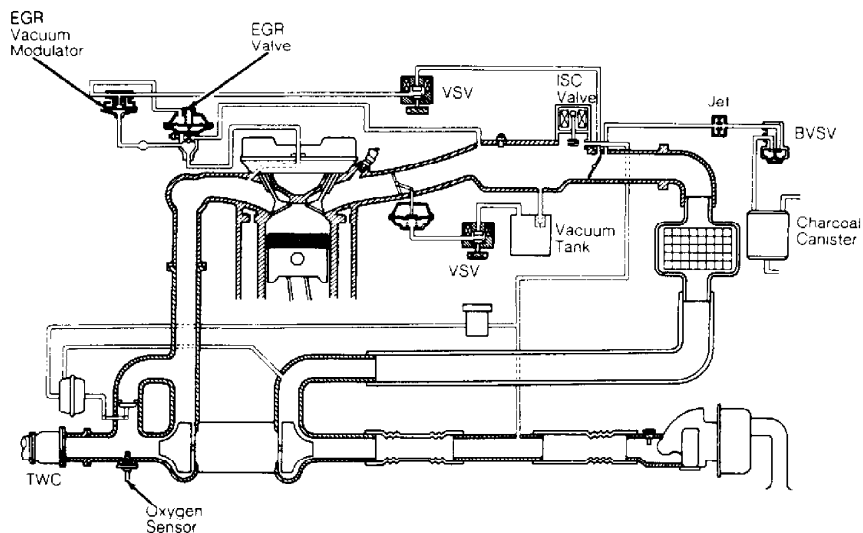

Fig. 4: Celica (All-Trac 4WD)  
 Courtesy of Toyota Motor Sales, U.S.A., Inc.

COROLLA

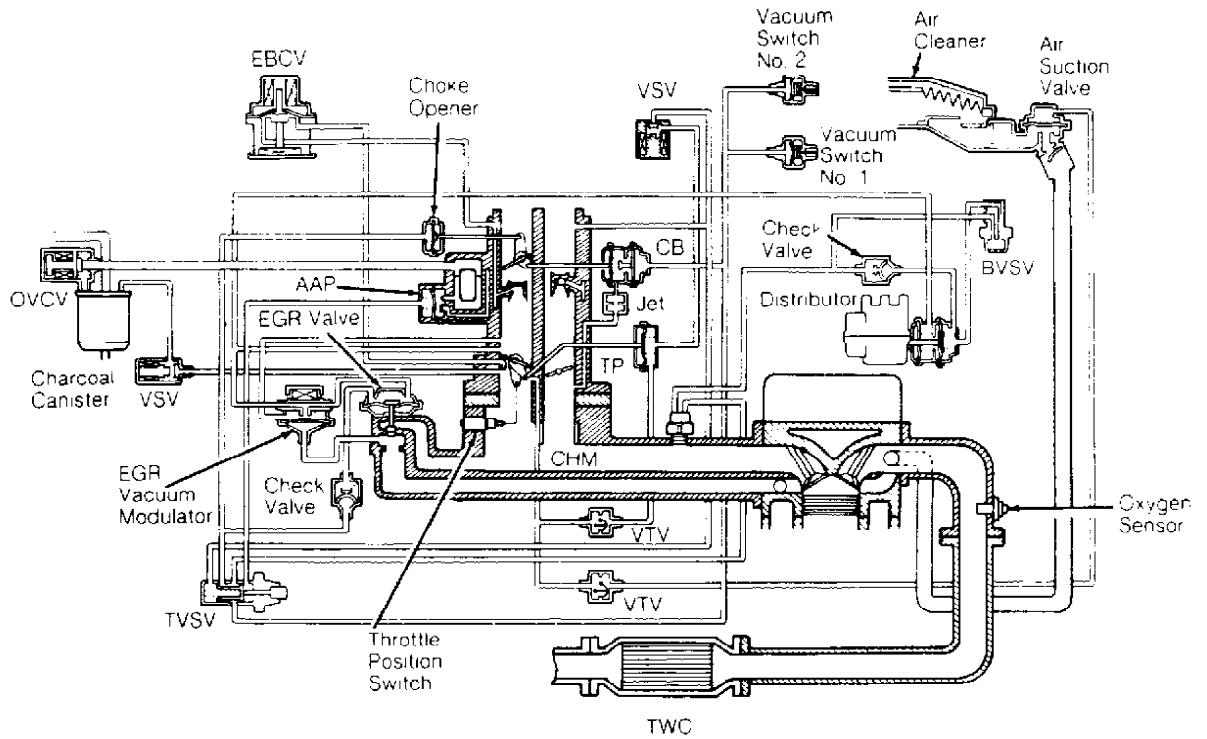

Fig. 5: Corolla 1.6L (California/ Carbureted)  
 Courtesy of Toyota Motor Sales, U.S.A., Inc.

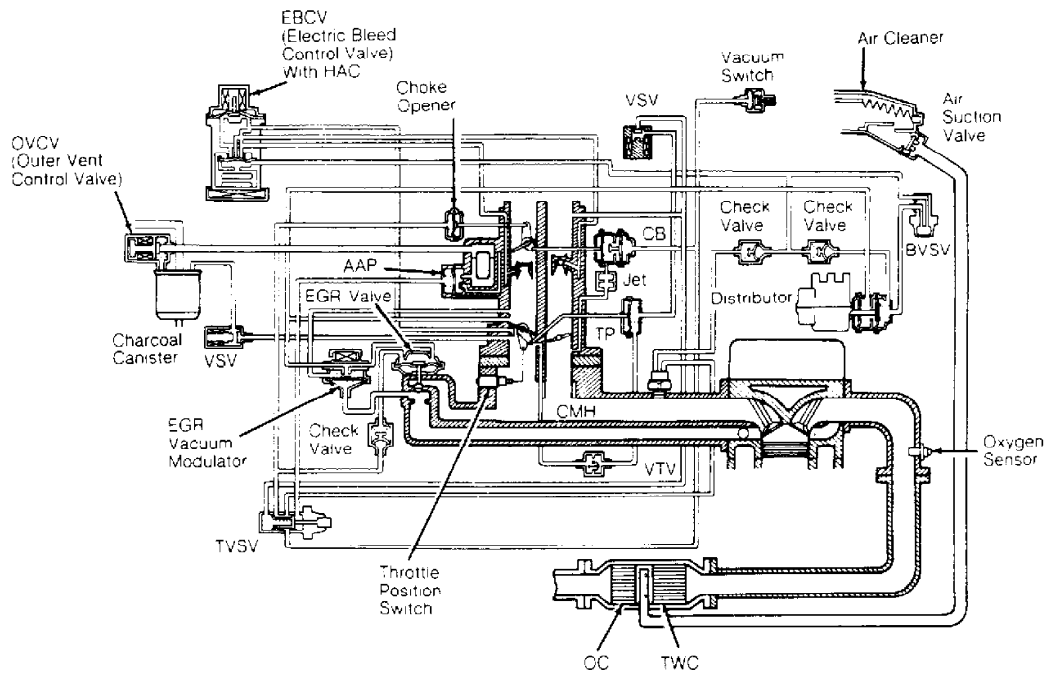

Fig. 6: Corolla a.6L (Federal / Carbureted)  
 Courtesy of Toyota Motor Sales, U.S.A., Inc.

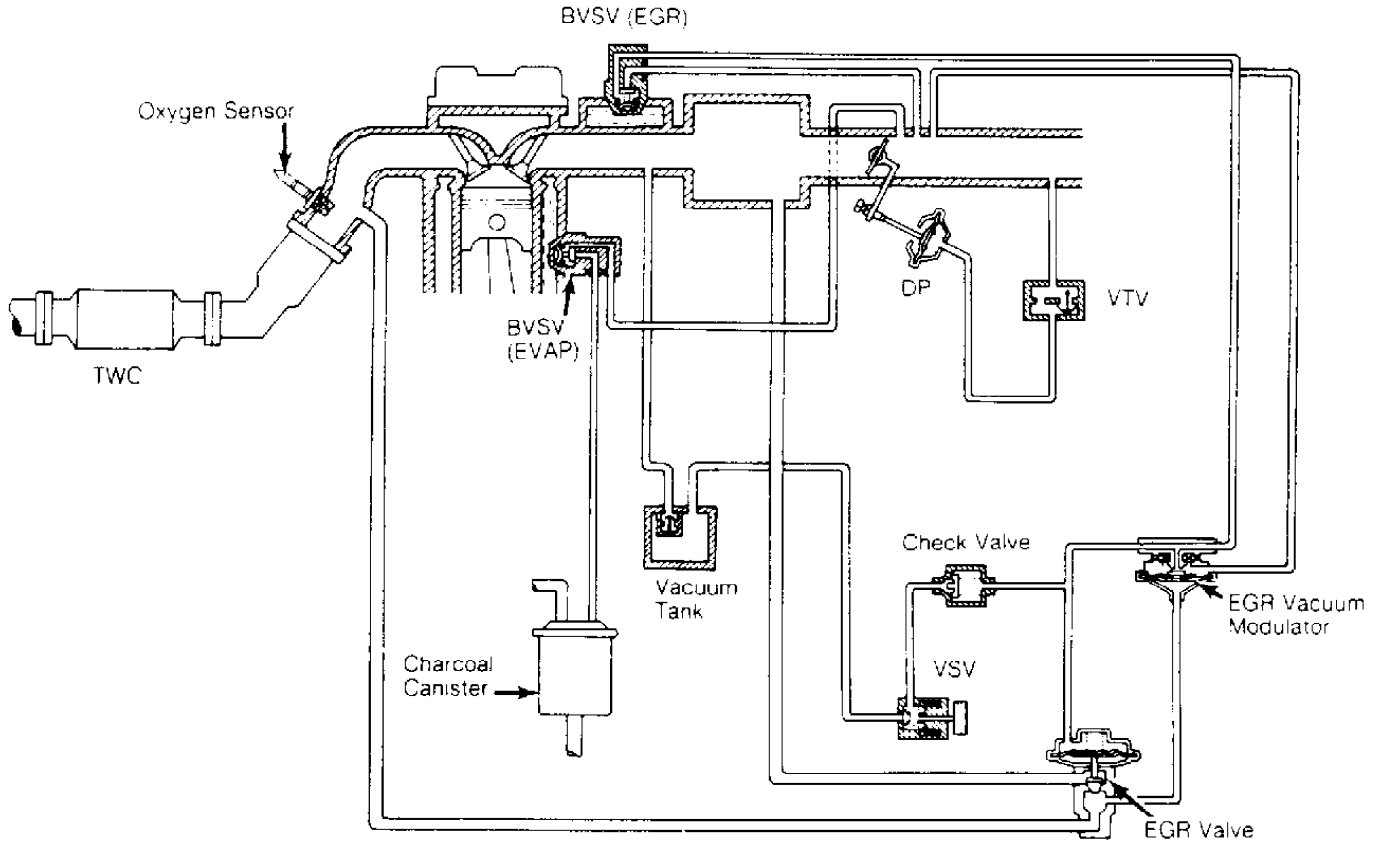

Fig. 7: Corolla 1.6L (EFI), FX, FX-16 (EFI) & MR2  
 Courtesy of Toyota Motor Sales, U.S.A., Inc.

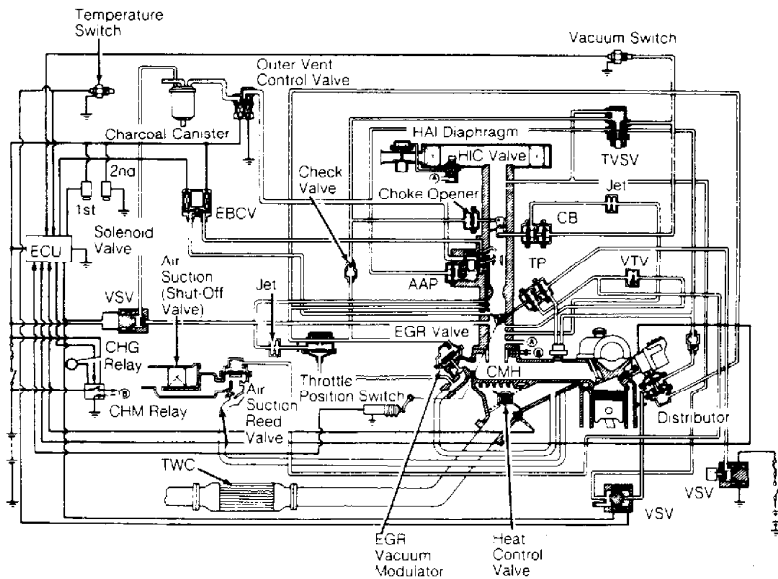

Fig. 8: Corolla 1.6L FX (Carbureted/California with A/T)  
 Courtesy of Toyota Motor Sales, U.S.A., Inc.

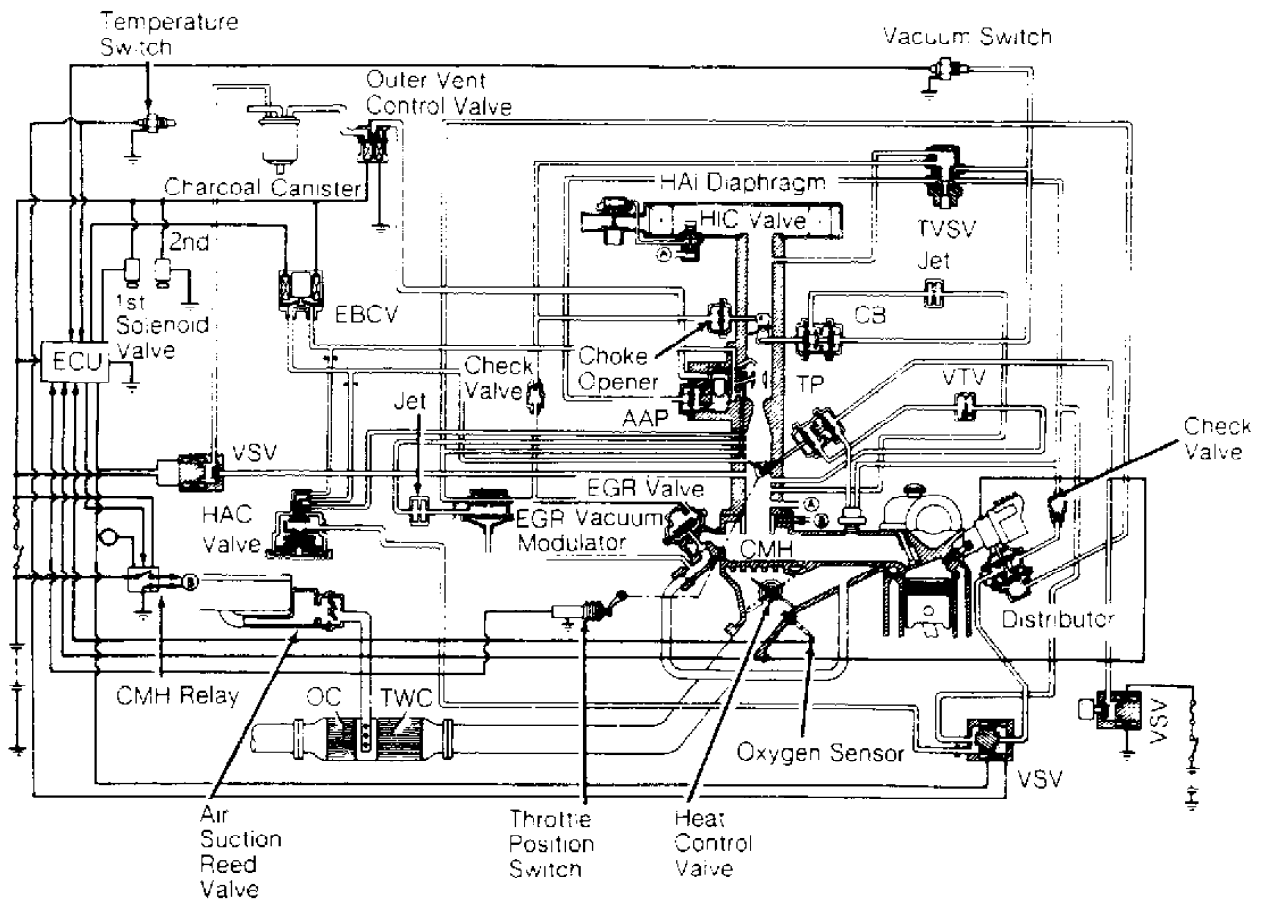

Fig. 9: Corolla 1.6L FX (Carbureted/Federal with A/T)  
 Courtesy of Toyota Motor Sales, U.S.A., Inc.

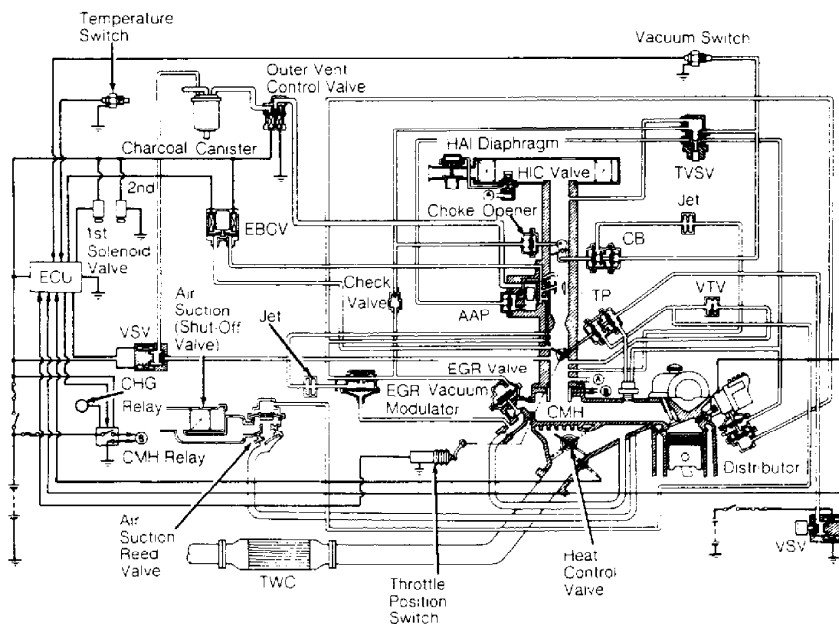

Fig. 10: Corolla 1.6L FX (Carbureted/California with M/T)  
 Courtesy of Toyota Motor Sales, U.S.A., Inc.

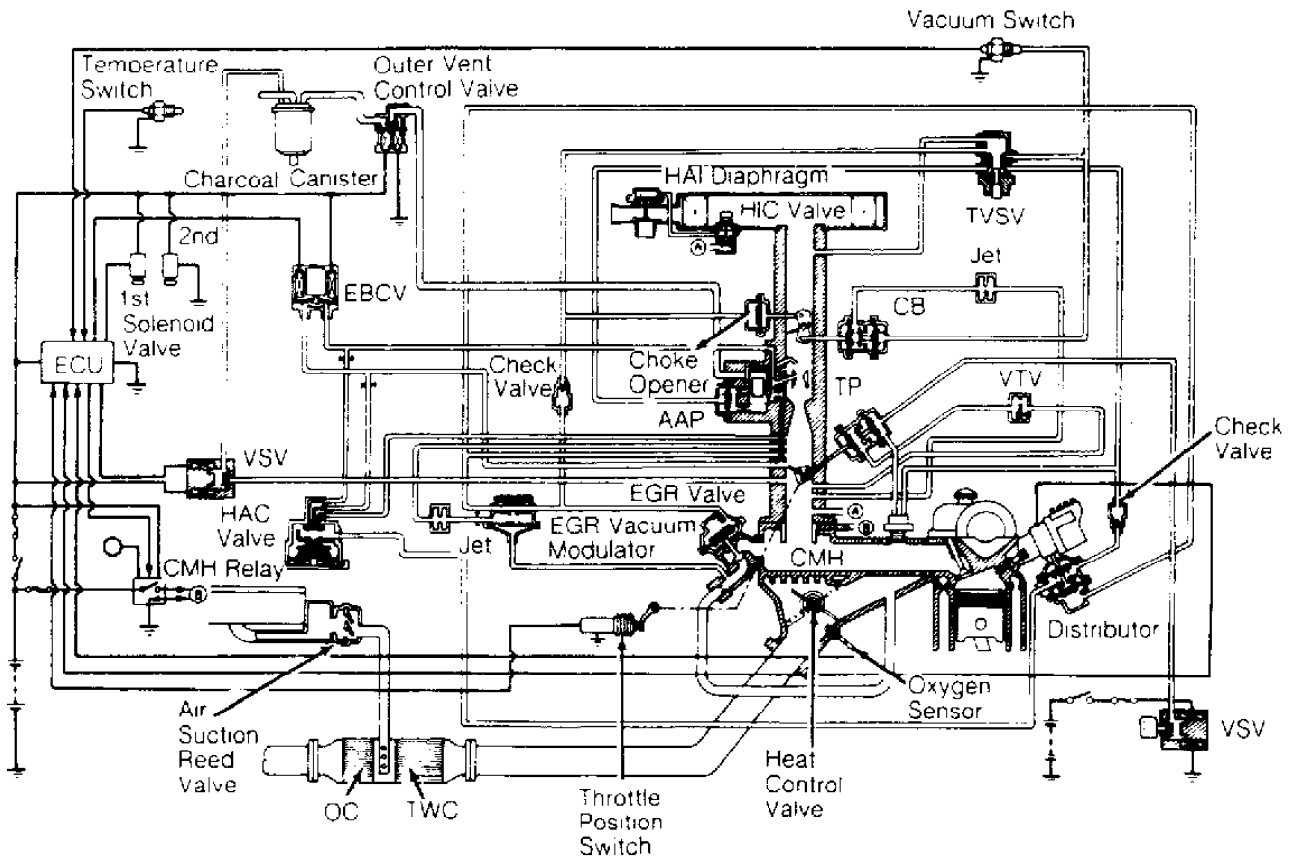

Fig. 11: Corolla 1.6L FX (Caarbureted/Federal with M/T)  
 Courtesy of Toyota Motor Sales, U.S.A., Inc.

CRESSIDA

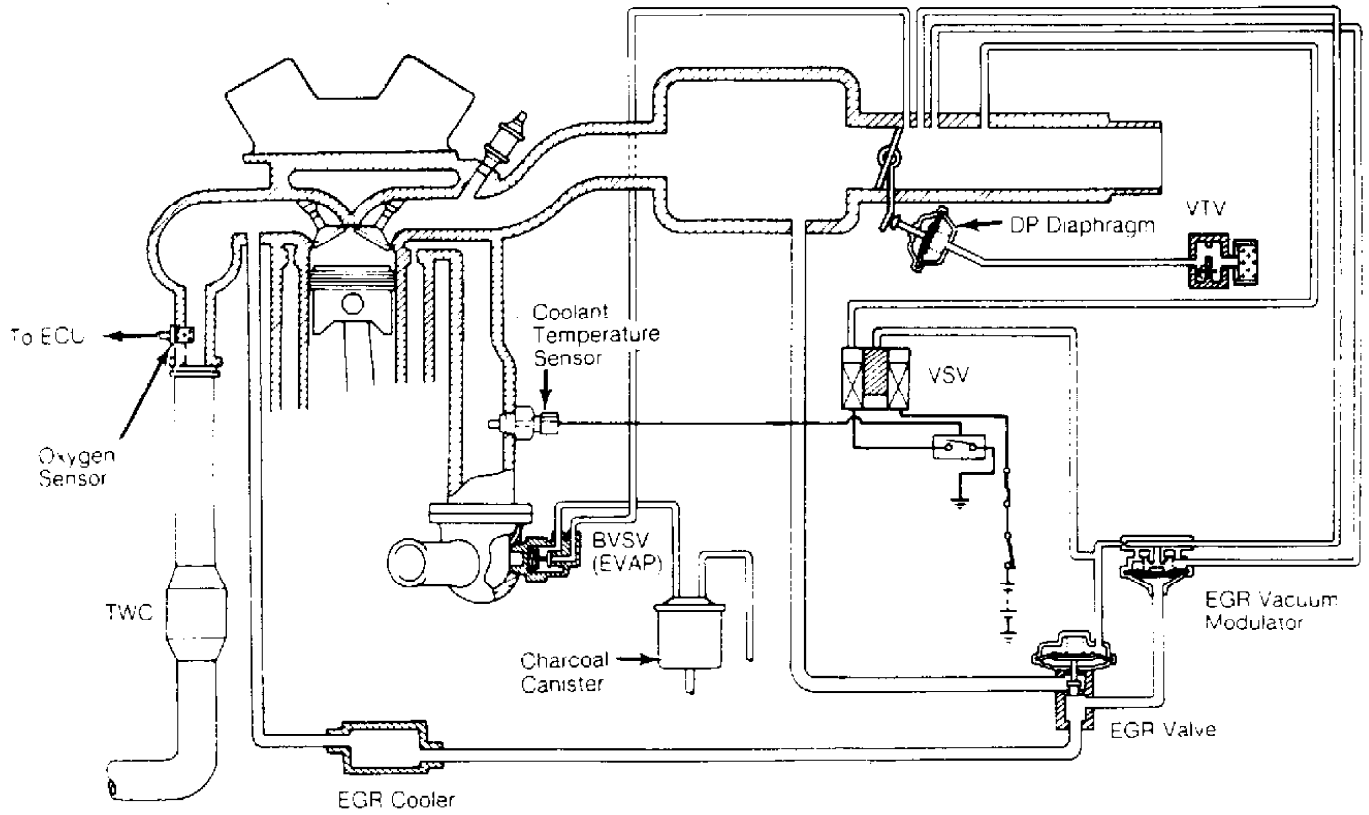

Fig. 12: Cressida 2.8L  
 Courtesy of Toyota Motor Sales, U.S.A., Inc.

LAND CRUISER



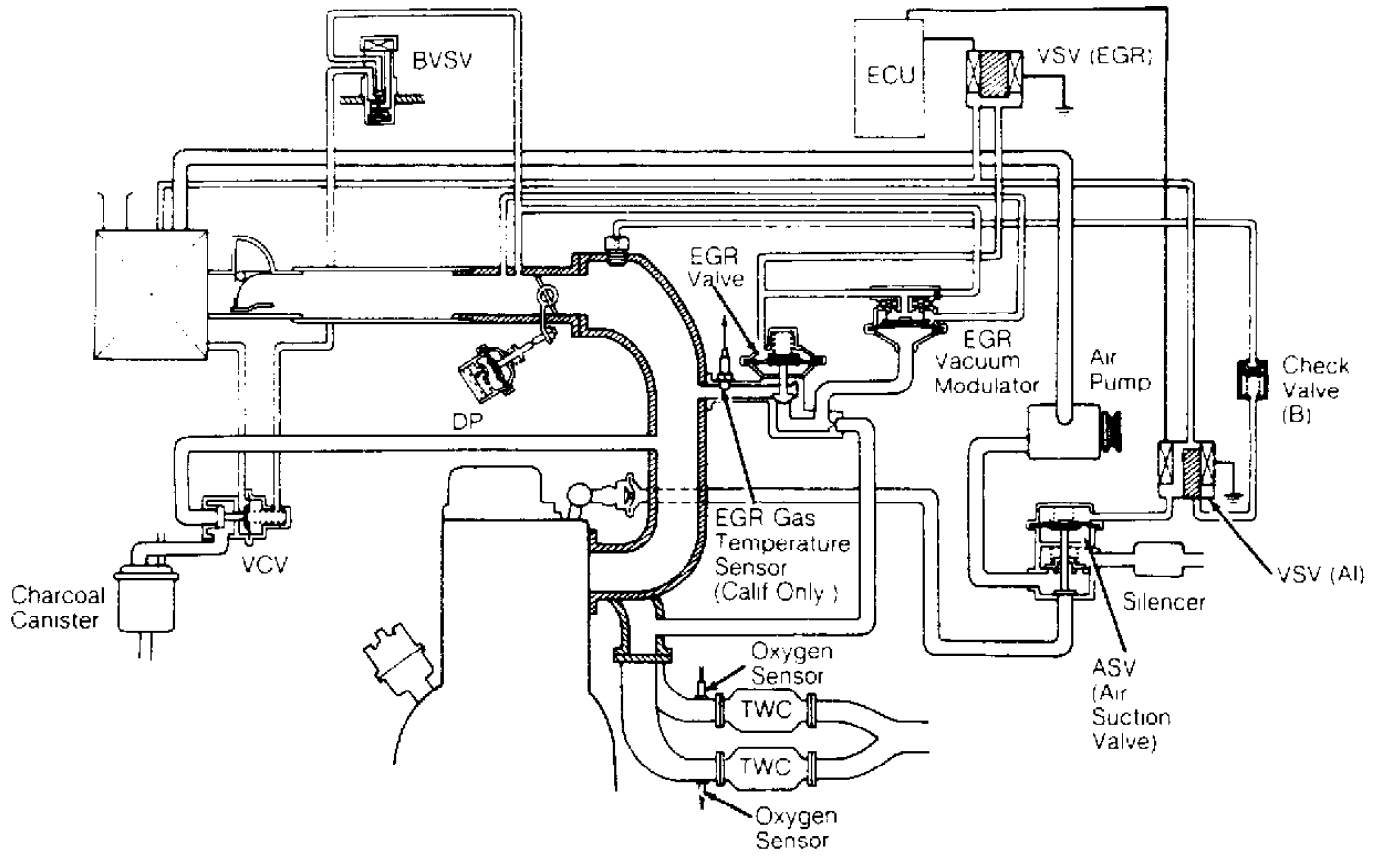

Fig. 13: Land Cruiser 4.1L  
 Courtesy of Toyota Motor Sales, U.S.A., Inc.

PICKUP & 4RUNNER

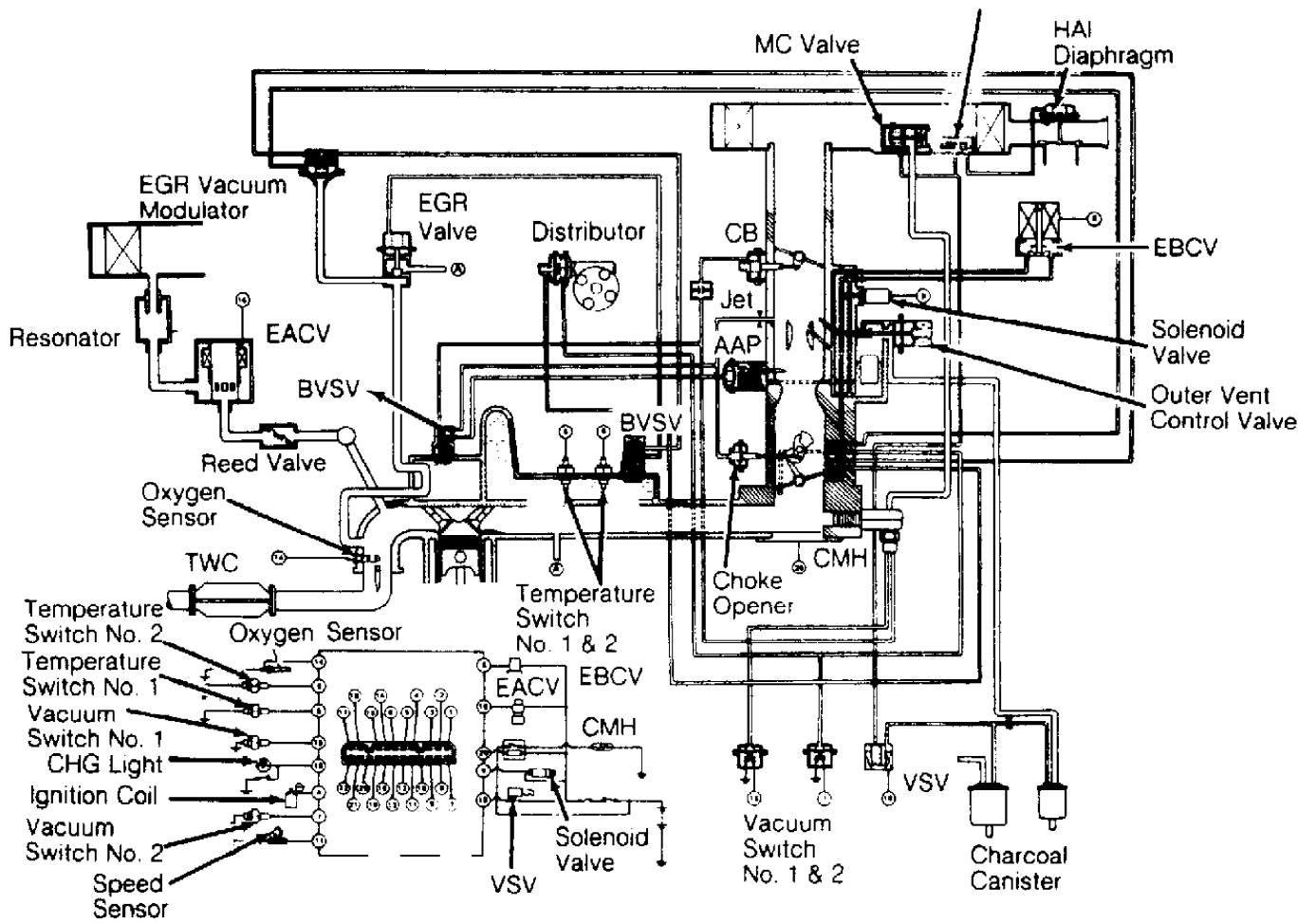

Fig. 14: Pickup 2.4L (California/Carbureted)  
 Courtesy of Toyota Motor Sales, U.S.A., Inc.

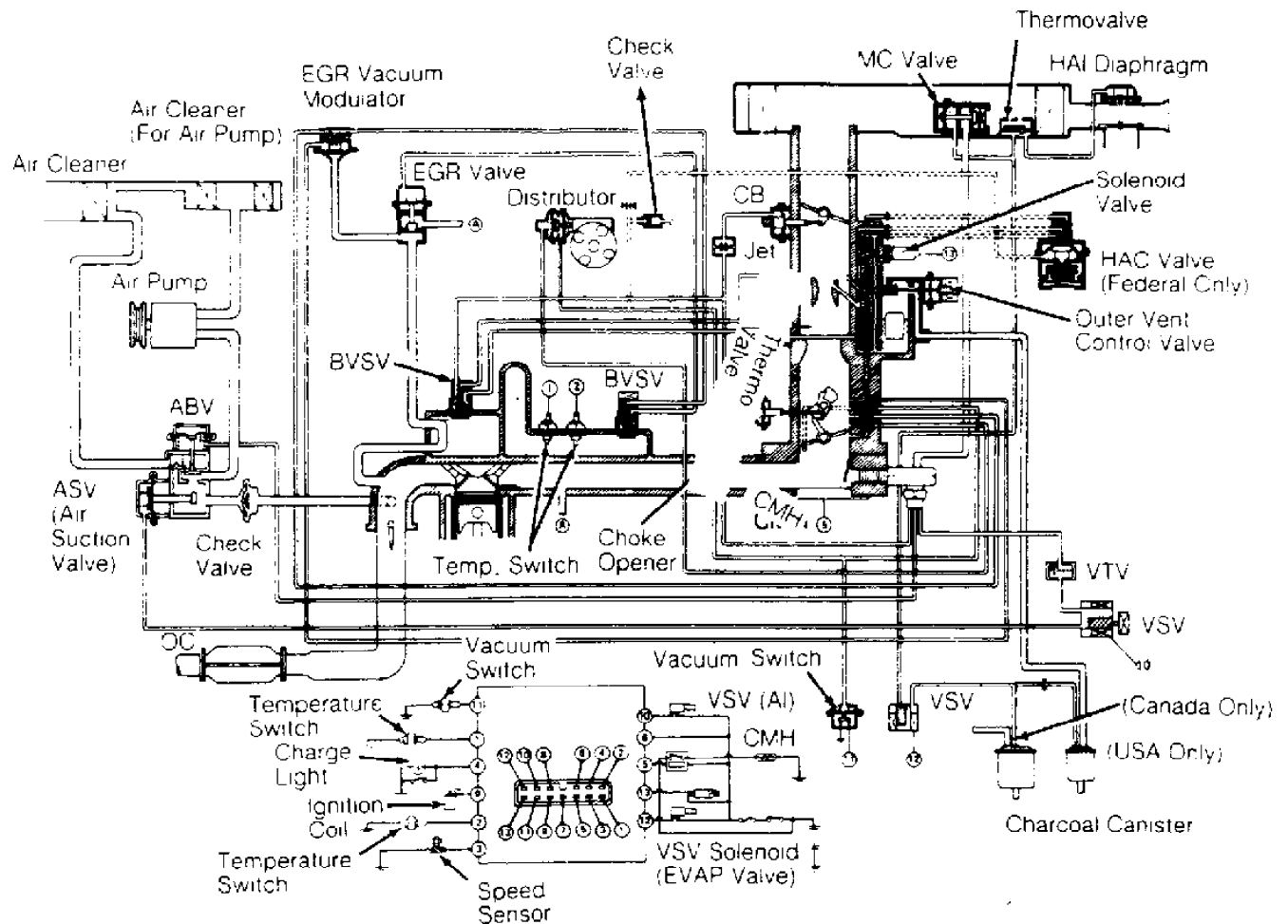

Fig. 15: Pickup 2.4L (Federal/Carbureted)  
 Courtesy of Toyota Motor Sales, U.S.A., Inc.

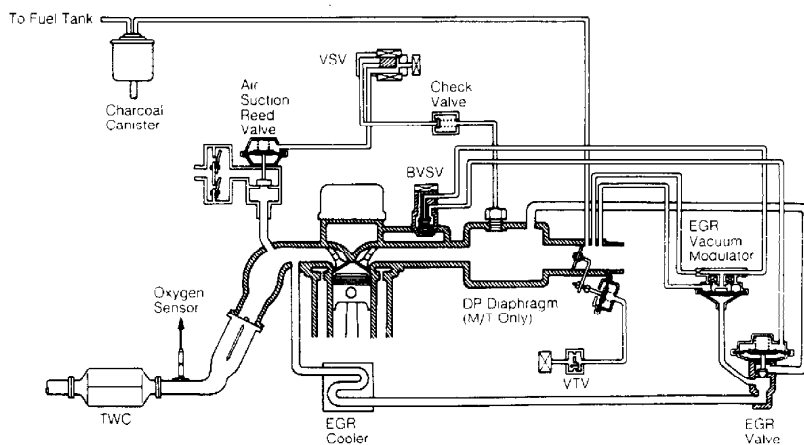

Fig. 16: Pickup-4Runner 2.4L (EFI, Non-Turbo)  
 Courtesy of Toyota Motor Sales, U.S.A., Inc.

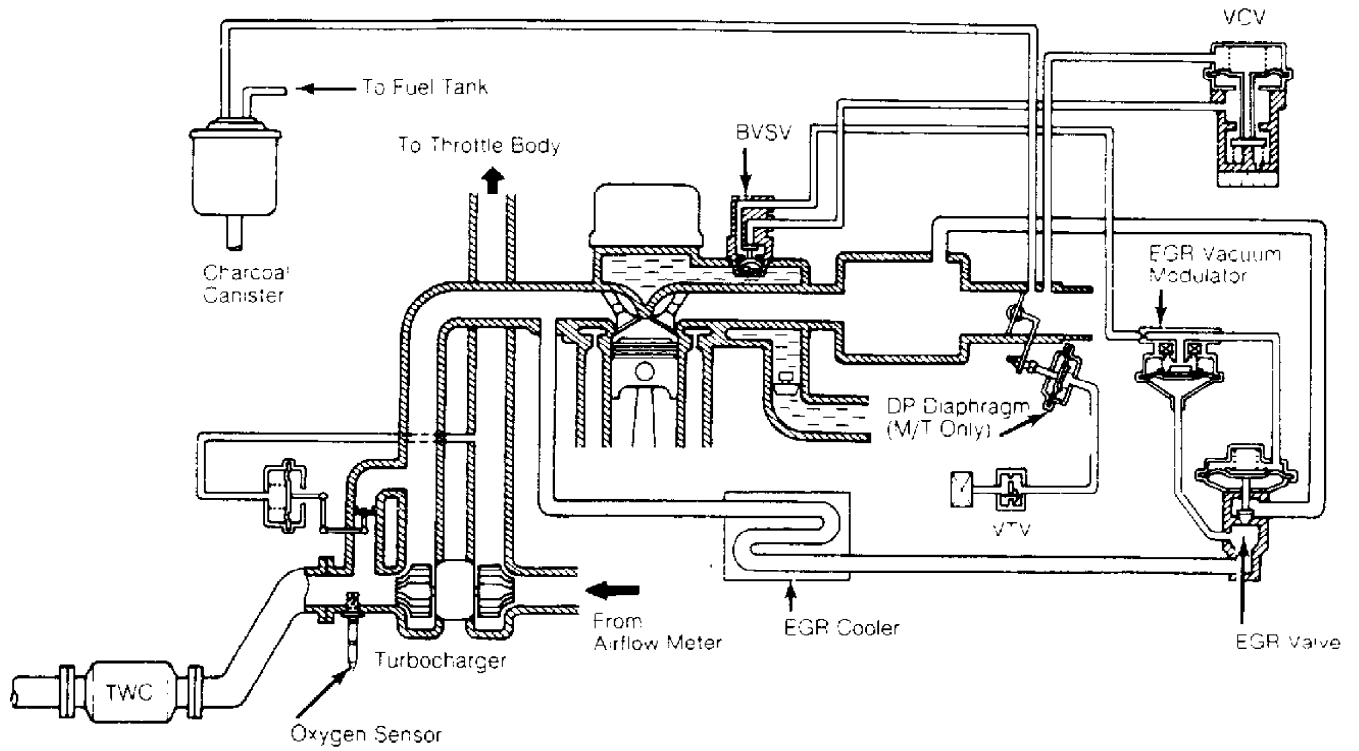

Fig. 17: Pickup & 4Runner 2.4L (EFI, Turbo)  
 Courtesy of Toyota Motor Sales, U.S.A., Inc.

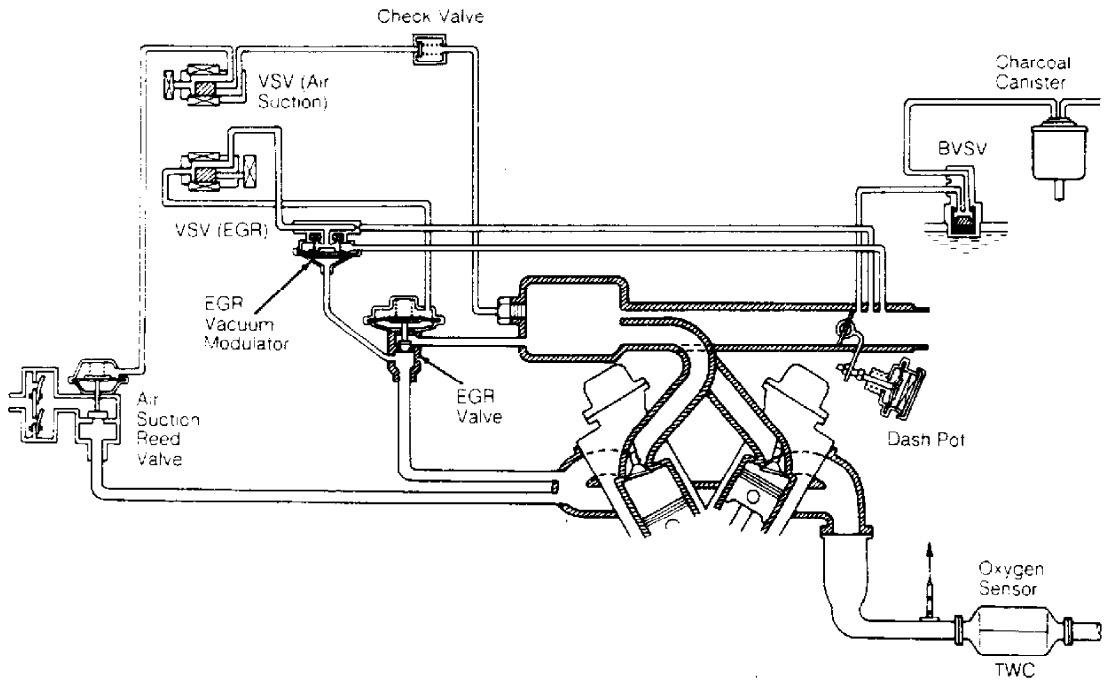

Fig. 18: Pickup & 4Runner .30L V6 (VZN Series)  
 Courtesy of Toyota Motor Sales, U.S.A., Inc.

SUPRA

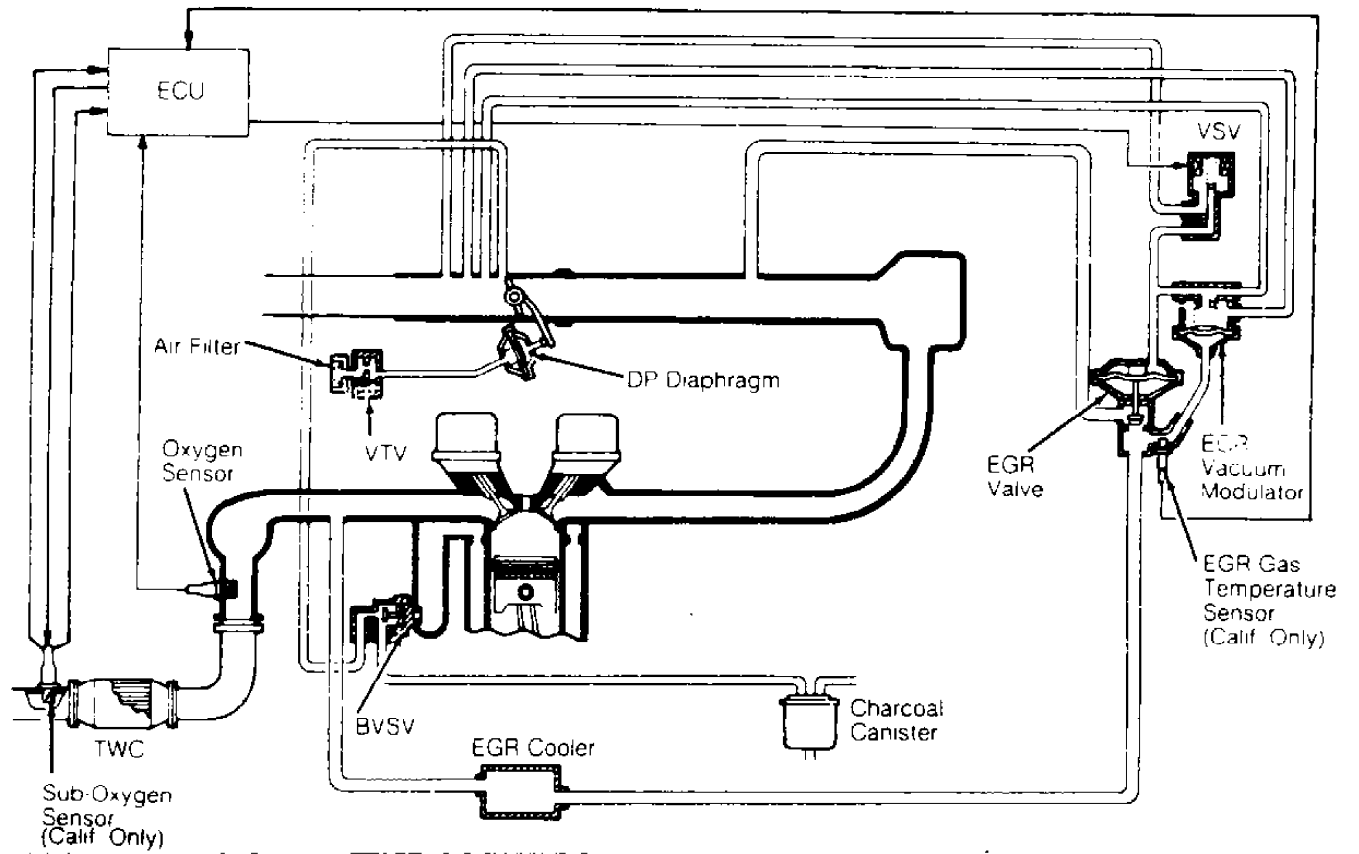

Fig. 19: Supra 3.0L (Non-Turbo)  
 Courtesy of Toyota Motor Sales, U.S.A., Inc.

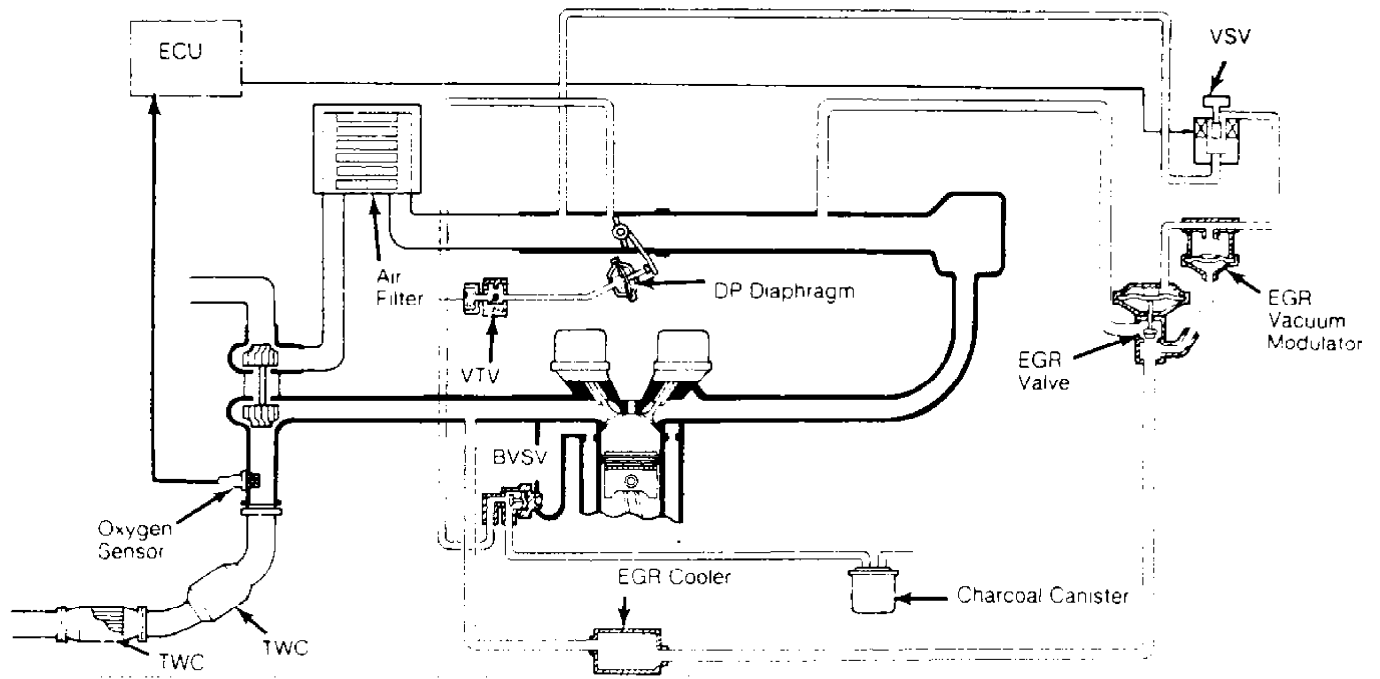

Fig. 20: Supra 3.0L (Turbo)  
 Courtesy of Toyota Motor Sales, U.S.A., Inc.

### TERCEL

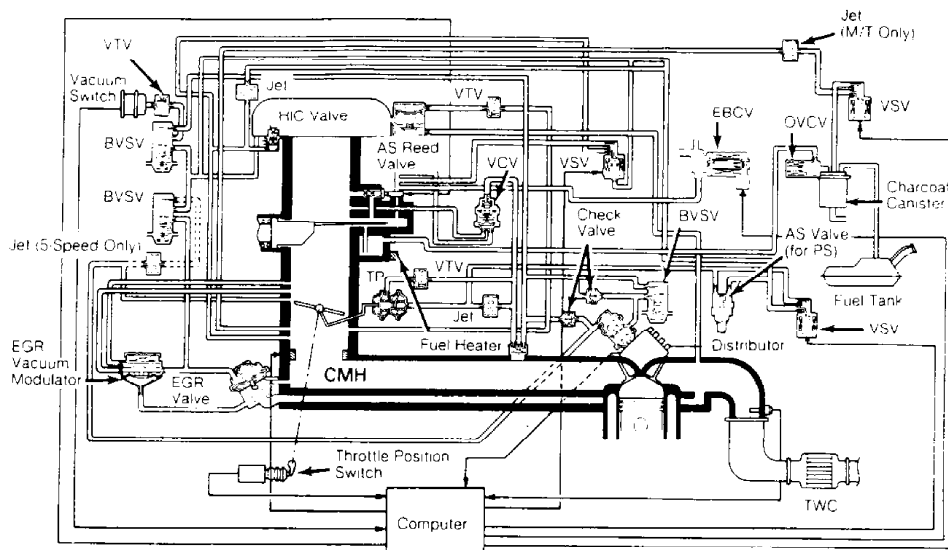

Fig. 21: Tercel 1.5L (California)  
 Courtesy of Toyota Motor Sales, U.S.A., Inc.

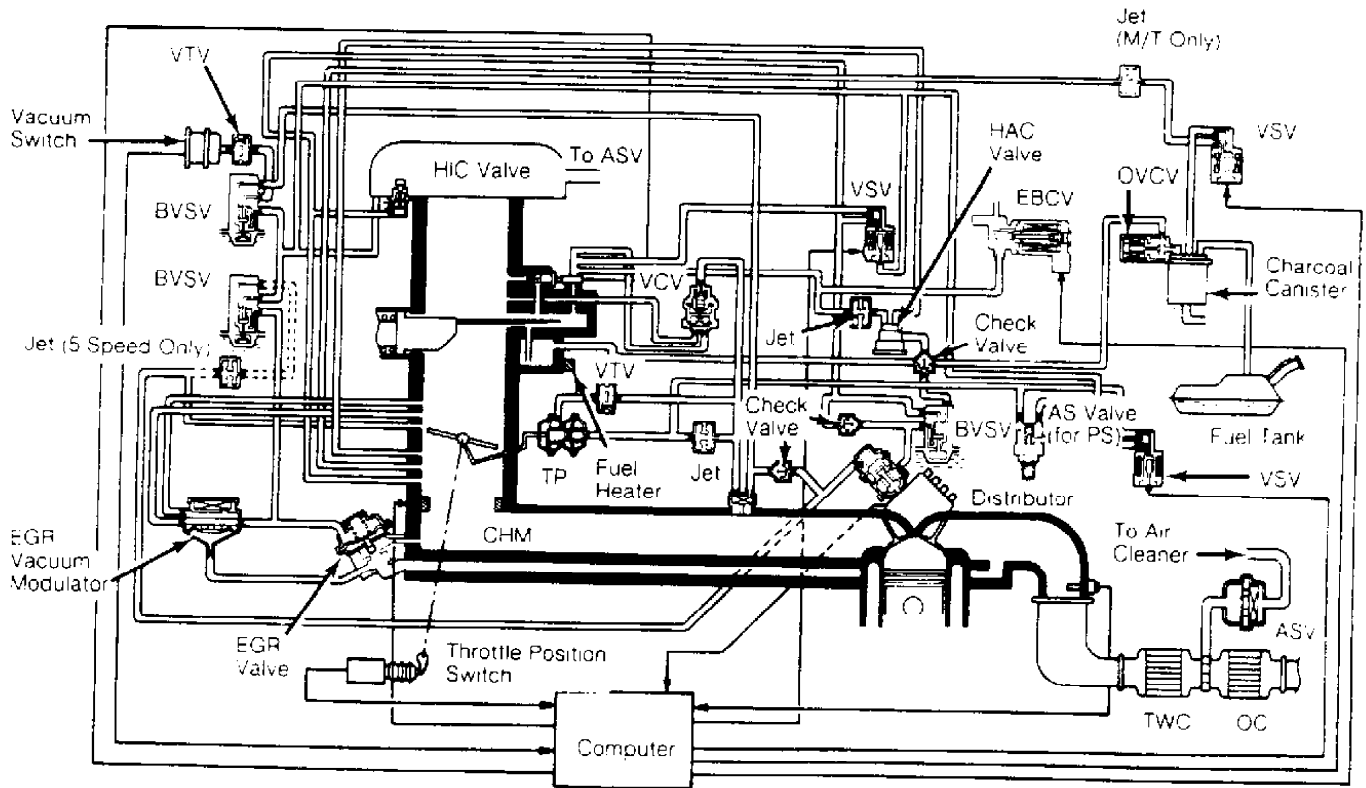

Fig. 22: Tercel 1.5L (Federal)  
 Courtesy of Toyota Motor Sales, U.S.A., Inc.

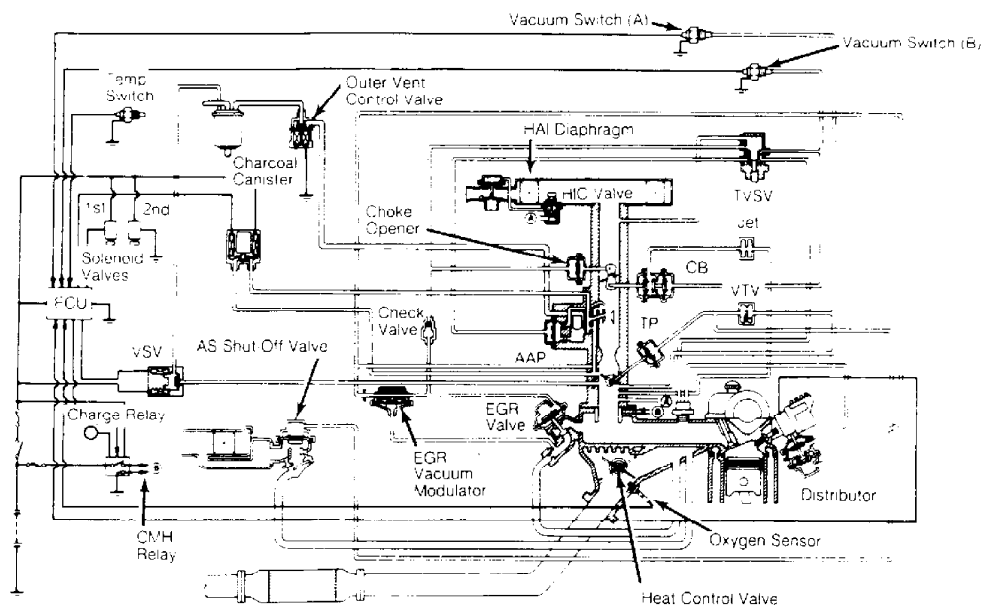

Fig. 23: Tercel Wagon 1.5L (California)  
 Courtesy of Toyota Motor Sales, U.S.A., Inc.

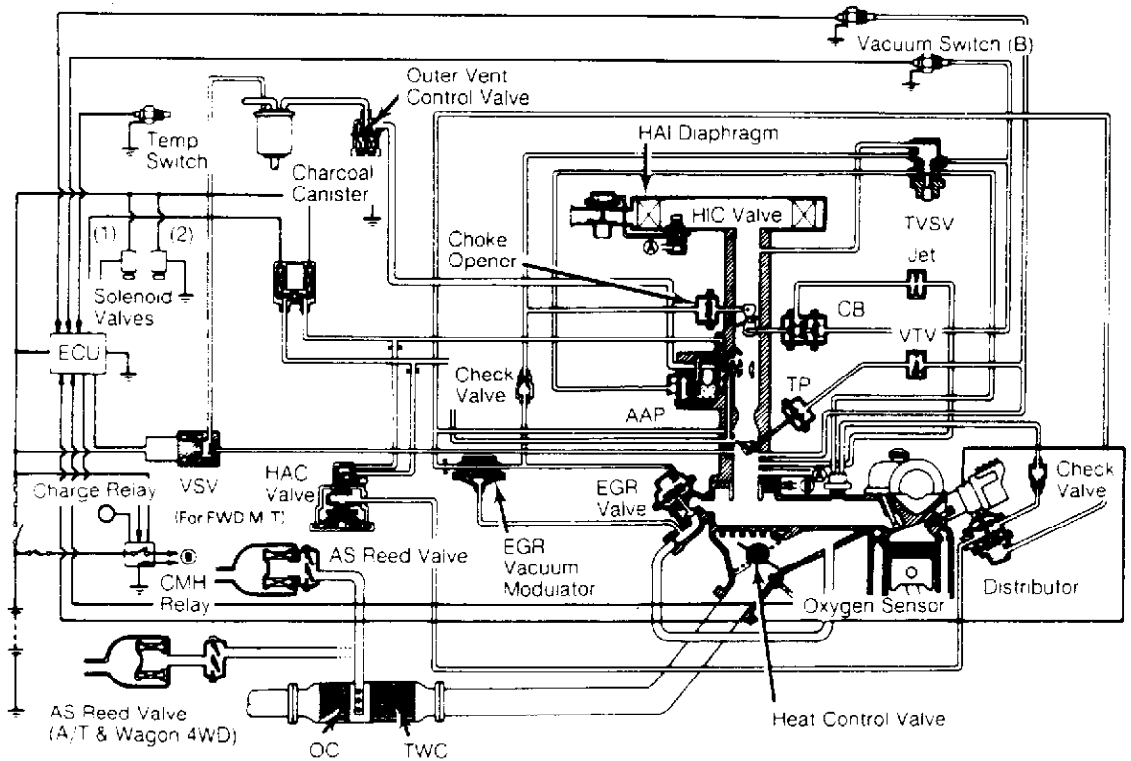

Fig. 24: Tercel Wagon 1.15L (Federal)  
 Courtesy of Toyota Motor Sales, U.S.A., Inc.

**VAN**

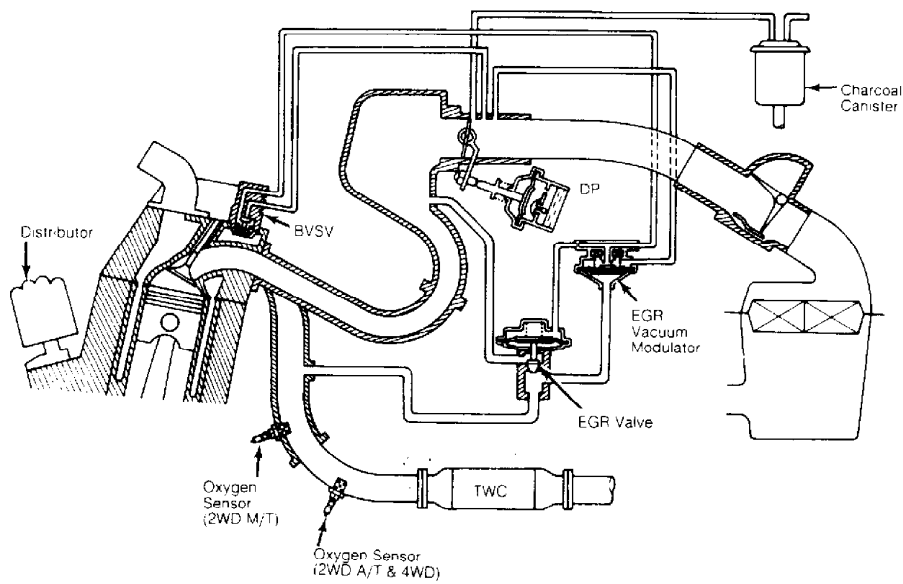

Fig. 25: Van 2.2L  
 Courtesy of Toyota Motor Sales, U.S.A., Inc.



